



ECLIPSE LV-N



Industrial Microscopes
LV150N / LV150NL / LV150NA
LV100ND / LV100DA-U



Together with new optics, ECLIPSE is evolving to the next stage.

The ECLIPSE microscope body has been modularized to meet industrial microscope applications in diverse fields of industry, including semiconductor devices, packaging, FPDs, electronic components, materials, and precision molds.

The ECLIPSE LV Series, with stand units and illumination units selectable according to observation method and purpose to meet a variety of observation methods, has gained a new optical system and new features in its continued evolution.

Four types – motorized and manual types plus dedicated reflected illumination and combined reflected/transmitted illumination types – are available to meet any application.

CFI60-2

Evolved optical performance

Nikon's CFI₆₀ optical system, highly evaluated for its unique concept of high NA combined with long working distance has further evolved to achieve the apex in long working distance, chromatic aberration correction, and light weight.

Easy Operation

Combination with digital camera

Detection of microscope information, including objective lens information, and motorized unit microscope operation are now possible using the digital control unit, for more efficient observation and image capture.

Observation Methods

Diverse observation methods

Combinations of a full range of accessories expand the observation methods available when using transmitted illumination, allowing adaptability to a greater diversity of samples.

All models enable brightfield, darkfield, differential interference, fluorescence, polarizing, and two-beam interferometry observation, while the LV100ND and LV100DA-U also allow transmission-type differential interference, darkfield, polarizing, and phase contrast observation.



LV-N Series

Model features



LV150N

NEW

LV150NL

(*Dedicated LED illumination models)



LV150NA

NEW



LV100ND

NEW



LV100DA-U

Dedicated reflected illumination models

Combined reflected/transmitted illumination models

Microscope type

Manual type

Motorized type
(Nosepiece)

Manual type

Motorized type
(Nosepiece / light intensity / aperture stop / observation method selector)

Compatible observation methods

		Brightfield	Darkfield	DIC	Fluorescence	Polarizing	Phase-contrast	Two-beam Interferometry
LV150/ LV150NA	Episcopic	○	○	○	○	○	—	○
LV150NL		○	—	○	—	○	—	○

* Use an objective lens appropriate to the observation method.

		Brightfield	Darkfield	DIC	Fluorescence	Polarizing	Phase-contrast	Two-beam Interferometry
LV100ND/ LV100DA-U	Episcopic	○	○	○	○	○	—	○
	Diascopic	○	○	○	—	○	○	—

* Use an objective lens appropriate to the observation method.

Compatible stages

- LV-S32 3x2 stage (Stroke: 75 x 50 mm with glass plate)
*Can be fitted with LV-S32SPL ESD plate
- LV-S6 6x6 stage (Stroke: 150 x 150 mm)
*Can be fitted with LV-S6WH wafer holder / LV-S6PL ESD plate
- LV-SRP P revolving stage
- P-GS2 G stage 2 (Used with stage adapter LV-SAD)

- LV-S32 3x2 stage (Stroke: 75 x 50 mm with glass plate)
*Can be fitted with LV-S32SGH slide glass holder
- LV-S64 6x4 stage (Stroke: 150 x 100 mm with glass plate)
- LV-SRP P revolving stage
- P-GS2 G stage 2 (Used with stage adapter LV-SAD)
- NIU-CSRR2 Ni-U right handle rotatable ceramic stage (Stroke: 78 x 54 mm)
- C-SR2S right handle stage (Stroke: 78 x 54 mm: Used with stage adapter LV-SAD)

Integration with Digital Sight microscopic digital camera

DS-L3 (Stand alone control unit)

- Objective lens information detection (when used with combination of Intelligent Nosepiece LV-NU5I and LV-INAD)

- Objective lens information detection and control



DS-U3 + NIS-Elements (PC control-based control unit + imaging software)

- Objective lens information detection (when used with combination of Intelligent Nosepiece LV-NU5I and LV-INAD)

- Objective lens information detection and control



DS-L3 (Stand alone control unit)

- Objective lens information detection (when used with combination of Intelligent Nosepiece LV-NU5I and LV-INAD)

- Information detection of objective lens, light intensity, aperture stop, and observation method (brightfield / darkfield / fluorescence)



DS-U3 + NIS-Elements (PC control-based control unit + imaging software)

- Objective lens information detection (when used with combination of Intelligent Nosepiece LV-NU5I and LV-INAD)

- Information detection and control of objective lens, light intensity, aperture stop, and observation method (brightfield / darkfield / fluorescence)



Evolved optical performance

Nikon's CFI60 optical system, highly evaluated for its unique concept of high NA combined with long working distance has further evolved to achieve the apex in long working distance, chromatic aberration correction, and light weight.

T Plan & TU Plan Fluor & TU Plan Apo Lenses Standard Plan objective lenses

Standard objective lenses

TU Plan Fluor series

EPI/BD 5x/10x/20x/50x/100x

These universal type standard objective lenses enable brightfield, darkfield, simple polarizing, sensitive polarizing, differential interference, and epi-fluorescence observation in one lens. New semi-apochromatic lenses combine superior chromatic aberration performance with long working distance at all magnifications to adapt to any application.



* Depicted is the brightfield observation (EPI) objective lens.

Model	Magnification	NA	Working Distance (mm)
TU Plan Fluor EPI (brightfield type)	5x	0.15	23.5
	10x	0.30	17.5
	20x	0.45	4.5
	50x	0.80	1.0
	100x	0.90	1.0
TU Plan Fluor BD (brightfield/darkfield type)	5x	0.15	18.0
	10x	0.30	15.0
	* 20x	0.45	4.5
	* 50x	0.80	1.0
	* 100x	0.90	1.0

* Uses fly-eye lenses.

Low-magnification objective lenses

T Plan EPI

EPI 1x/2.5x

These low-magnification objective lenses enable clear observation using a conventional analyzer/polarizer, as well as operability-oriented observation without need for an analyzer/polarizer.



Model	Magnification	NA	Working Distance (mm)
T Plan EPI (brightfield type)	1x	0.03	3.8
	2.5x	0.075	6.5

Apochromatic objective lenses

TU Plan Apo series

EPI/BD 50x/100x/150x

By using phase Fresnel lenses, these objective lenses achieve significantly longer operating distances while maintaining the superior chromatic aberration performance of apochromatic lenses. A 50x lens is new to the line-up.



* Depicted is the brightfield observation (EPI) objective lens.

Model	Magnification	NA	Working Distance (mm)
TU Plan Apo EPI (brightfield type)	50x	0.8	2.0
	100x	0.9	2.0
	150x	0.9	1.5
TU Plan Apo BD (brightfield/darkfield type)	50x	0.8	2.0
	100x	0.9	2.0
	150x	0.9	1.5

New darkfield illumination system

As NA and W.D. improve, objective lenses increase in outside diameter. However, as the width of incident light is fixed, light intensity decreases with conventional illumination systems. The new illumination system uses annular lenses or annular prisms to increase captured light and achieve bright darkfield illumination with no deterioration.

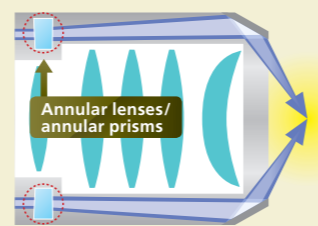

Annular lenses/prisms take in more light to increase brightness

Dark Field Illumination

Fly-eye lens

As low-magnification lenses normally have a wide actual field of view, it is difficult to achieve bright illumination without unevenness. Through the use of fly-eye lenses, the CFI60-2 optical system offers bright darkfield illumination throughout the field of view, with little unevenness.

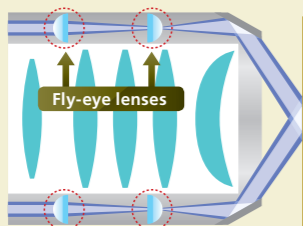

Fly-eye lenses adjust the diffusion angle of light so light strikes the focal surface without unevenness

TU Plan ELWD & T Plan SLWD Lenses Long working distance / Super-long working distance objective lenses

Long working distance objective lenses

TU Plan ELWD Series

EPI/BD 20x/50x/100x



Through the use of phase Fresnel lenses, these objective lenses enable long working distances while offering higher-level chromatic aberration correction than conventional objective lenses. This further improves operability for samples with differences in level.

* Depicted is the brightfield observation (EPI) objective lens.

Model	Magnification	NA	Working Distance (mm)
TU Plan EPI ELWD (brightfield type)	20x	0.4	19.0
	50x	0.6	11.0
	100x	0.8	4.5
TU Plan BD ELWD (brightfield/darkfield type)	* 20x	0.4	19.0
	* 50x	0.6	11.0
	* 100x	0.8	4.5

* Uses new darkfield illumination system.

Super-long working distance objective lenses

T Plan EPI SLWD

EPI 10x/20x/50x/100x



Improving on chromatic aberration while further advancing the concept of prioritizing working distance, the T Plan SLWD Series of super-long working distance semi-apochromatic objective lenses achieves best-in-class super-long working distance. The new addition of a SLWD 10x (WD: 37mm) lens to the line-up enables use with a greater diversity of samples.

* Scheduled for sale from January 2013.

Model	Magnification	NA	Working Distance (mm)
T Plan EPI SLWD (brightfield type)	10x	0.2	37.0
	20x	0.3	30.0
	50x	0.4	22.0
	100x	0.6	10.0

Phase Fresnel

Color aberration correction

Conventional lenses rely upon the refraction of light to form an image. As the strength of refraction varies according to color (wavelength), the image is formed in the order of blue, green, and red, starting with light closest to the lens. In contrast, a phase Fresnel lens uses diffraction of light to form an image in the order of red, green, and blue, starting with light closest to the lens, thus yielding a property opposite that of refraction. Combining these two lenses cancels out the color aberration of each and enables an image with little color aberration.

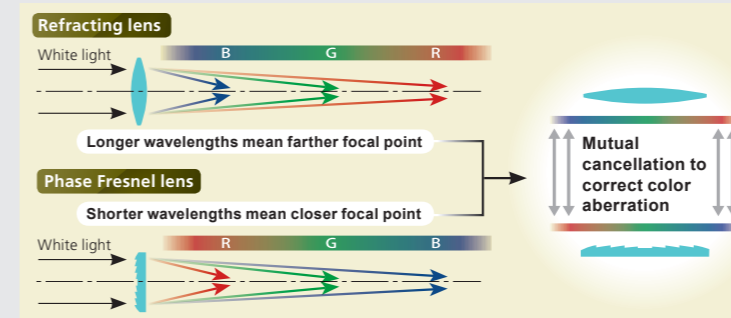

Realization of Long Working Distance

Through the use of phase Fresnel lenses, correction of color aberration is possible even with short distances between lenses, enabling a longer working distance than possible with conventional lenses.

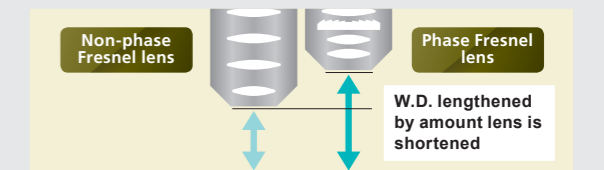

Other objective lenses

Objective lenses with glass thickness correction features

CFI L Plan EPI CR 20x/50x/100x

These objective lenses are equipped with corrective features that enable high-contrast observation of cells or patterns, unaffected by the glass substrate.



Model	Magnification	NA	Working Distance (mm)
CFI L Plan EPI CR (brightfield type)	20x CR	0.45	10.90 - 10.00
	50x CR	0.70	3.90 - 3.00
	100x CRA	0.85	1.20 - 0.85
	100x CRB	0.85	1.30 - 0.95

Objective lenses for interferometry / Objective lenses for two-beam interferometry

CF IC EPI Plan TI/DI DI 10x/20x/50x/100x TI 2.5x/5x

These Michelson (TI) and Mirau (DI) two-beam interferometry lenses allow inspection and measurement of fine level differences without contact with the sample.



Model	Magnification	NA	Working Distance (mm)
CF IC EPI Plan TI (for interferometry)	2.5xA	0.075	10.30
	5xA	0.130	9.30
CF IC EPI Plan DI (for two-beam interferometry)	10xA	0.30	7.40
	20xA	0.40	4.70
	50xA	0.55	3.40
	100x	0.70	2.00

Easy Operation

Combination with digital camera

LV150N/LV100ND/LV150NA

Objective lens information detection and control

Through the combination of the Intelligent Nosepiece LV-NU5I and the newly-developed magnification-detecting nosepiece adaptor LV-INAD, the LV150N/LV100ND microscopes allow information about the objective lens currently used to be detected via the camera control unit. The information is automatically converted to appropriate calibration data when changing magnification.

In addition to the detection of objective lens information, the LV150NA allows detection of objective lens information and switching of objective lenses via the camera control unit.

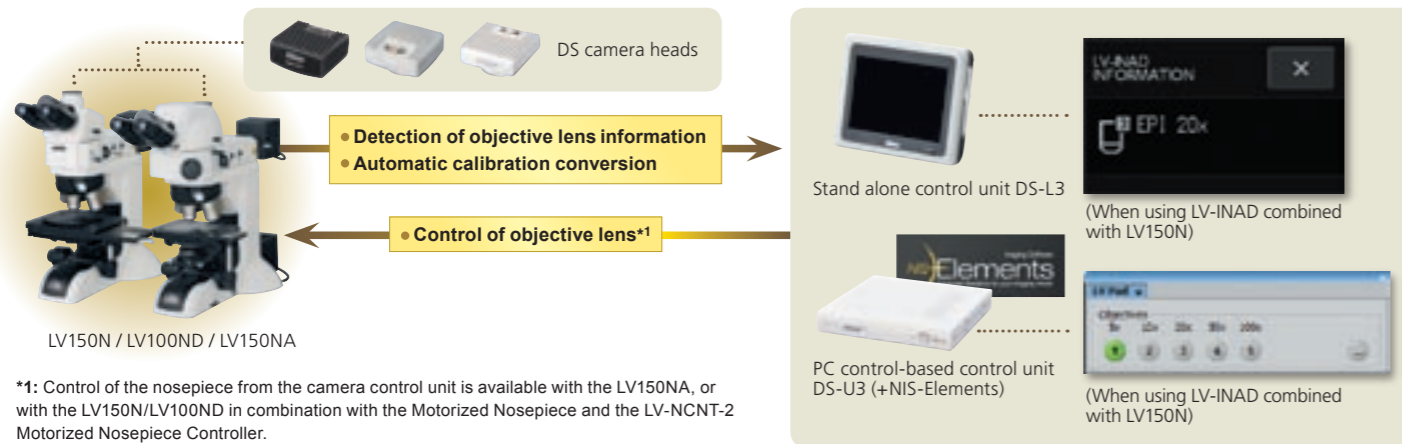

*1: Control of the nosepiece from the camera control unit is available with the LV150NA, or with the LV150N/LV100ND in combination with the Motorized Nosepiece and the LV-NCNT-2 Motorized Nosepiece Controller.

LV100DA-U

Microscope information detection and control

The LV100DA-U allows detection of information and control*2 of objective lenses, light intensity, aperture stop, and observation method (brightfield / darkfield / fluorescence) via the camera control unit, enabling optimization of the conditions vital for image acquisition.

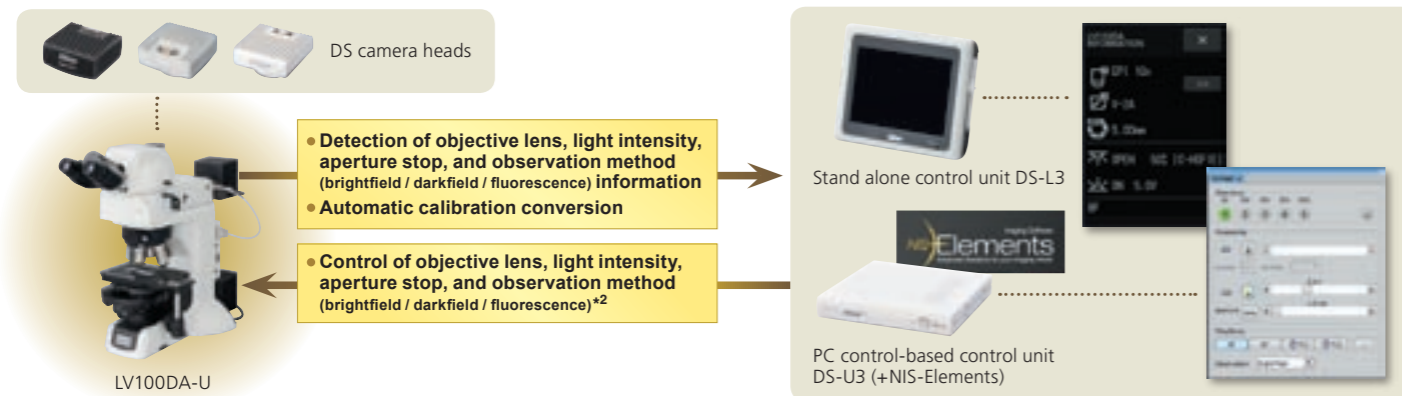

*2: Information detection only, when the control unit DS-L3 is connected. Control of the objective lens, light intensity, aperture stop, and observation method (brightfield / darkfield / fluorescence) is possible when the control unit DS-U3 (+NIS-Elements) is connected.

Compatibility Chart of Information Detection and Control by Model

	LV150N/LV100ND (When using LV-NU5I and LV-INAD)		LV150NA		LV100DA-U (When using LV-UEPI2A Illuminator)	
	DS-L3	DS-U3 (+NIS-Elements)	DS-L3	DS-U3 (+NIS-Elements)	DS-L3	DS-U3 (+NIS-Elements)
Objective lens	○	○	⊙	⊙	○	⊙
Reflected illumination (ON/OFF, light intensity adjustment)	—	—	—	—	○	⊙
Transmitted illumination (ON/OFF, light intensity adjustment)	—	—	—	—	○	⊙
Aperture stop	—	—	—	—	○	⊙
Observation method selector (brightfield / darkfield / fluorescence)	—	—	—	—	○	⊙

* NIS-Elements F (free package) is not compatible with information detection and control. Please use NIS-Elements D/Br/Ar.

Control Units

Digital camera system for microscopy "Digital Sight System"



Stand alone control unit

DS-L3

Equipped with a large touch panel monitor and a rich feature set, the DS-L3's ease of operation enables quick image acquisition even without a PC or computer monitor.



High-definition touch panel monitor

Built-in 8.4" 1024 x 768 monitor. Easy to see and easy to use, the large touch-panel monitor allows simple setting and operation of the camera head with a touch of a finger or stylus.

Scene mode

Optimal imaging parameters for each sample type and observation method can easily be set through the icons.

- Wafer/IC
- Metal, Ceramic/Plastic
- Circuit board
- Flat Panel Display



A wide variety of tools

The DS-L3 enables the conducting of simple measurements on images, with input of lines and comments. These can also be written onto and saved with the image, and measurement data can be output.



Measurement (2 point distance)

Measurement function



Position and size comparison functions



Drawing functions



PC control-based control unit

DS-U3

From display and shooting of live images to advanced image processing and analysis, the DS-U3 allows the control of all functions from a PC and is flexibly adaptable to a wide range of applications.



Adaptable to a wide range of applications

Using NIS-Elements imaging software, you can perform image acquisition, processing, and analysis.

NIS-Elements Comprehensive imaging software series

NIS-Elements series as control software. NIS-Elements allows functions from basic imaging to control of the microscope and peripheral devices to be performed, as well as the measurement, analysis, and management of acquired images.

Large image

Stitches together images from multiple fields of view during shooting to create an image with wide field of view. Images already acquired can also be stitched together.

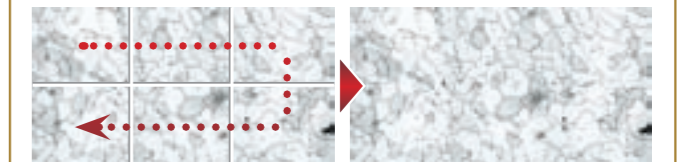

Manual measurement and image annotation

Manual Measurement allows easy measurement of length and area by drawing lines or an object directly on the image. The results can be attached to the image, and also exported as text or to an Excel spreadsheet.

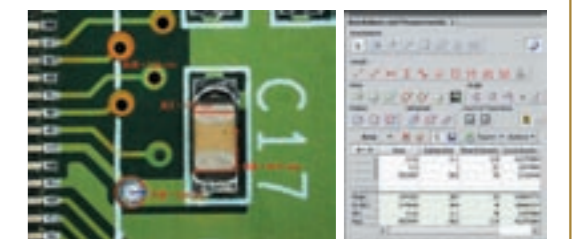

* See the "Digital Camera Digital Sight Series for Microscopes" catalog for details on Digital Sight features.

Observation Methods

Compatible with a wide range of observation methods: brightfield, darkfield, polarizing, differential interference, epi-fluorescence, and two-beam interferometry.

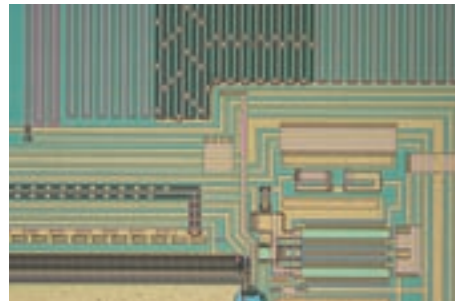

Brightfield
LV150N LV150NA LV100ND LV100DA-U

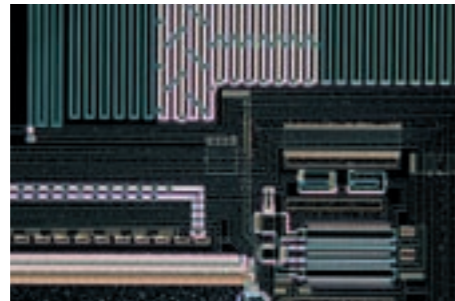

Darkfield
LV150N LV150NA LV100ND LV100DA-U

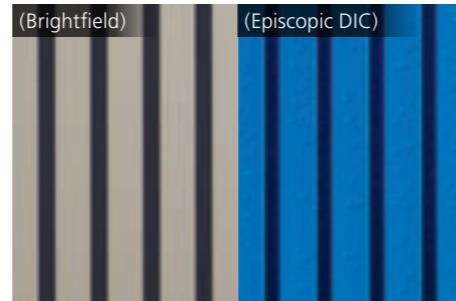

Episcopic DIC
LV150N LV150NA LV100ND LV100DA-U

Semiconductors (IC wafers)

From its objective lenses to its illumination systems, the LV-N Series offers thorough measures against flare and provides bright, high-contrast images.

Semiconductors (IC wafers)

The use of Nikon's unique concepts in the objective lens darkfield illumination system enables bright darkfield observation and provides high-sensitivity detection of level differences and defects in samples.

Substrate

Standard-type and high-contrast-type DIC sliders are available to match samples. The LV-N Series is effective for applications such as observation of minute level differences in devices and precision molds.

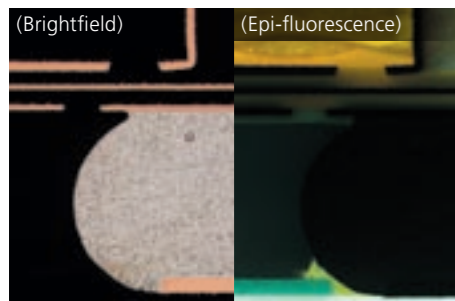

Epi-fluorescence
LV150N LV150NA LV100ND LV100DA-U

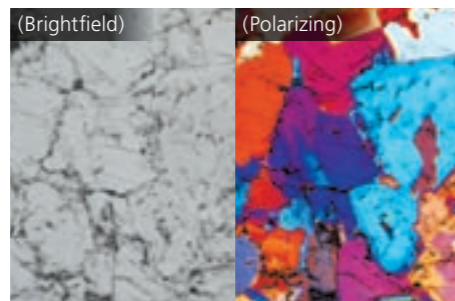

Polarizing
LV150N LV150NA LV100ND LV100DA-U

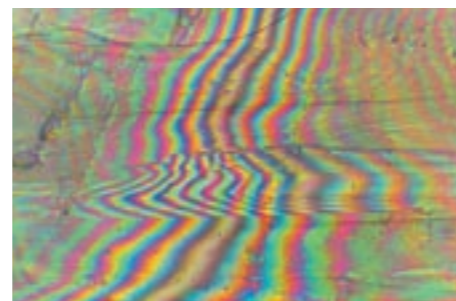

Two-beam Interferometry
LV150N LV150NA LV100ND LV100DA-U

Substrate (solder)

The LV-N Series demonstrates superiority in the observation of samples with fluorescent properties, such as organic ELs or mounted substrates.

Minerals

The LV-N Series is effective in the observation of samples with birefringent properties, such as liquid crystals or plastics/glass containing distortion.

Mica

Michelson (TI) and Mirau (DI) reflection-type two-beam interferometry is possible with the LV-N Series. When used with micrometer eyepieces, minute level differences can be detected and measured without contact with the sample.

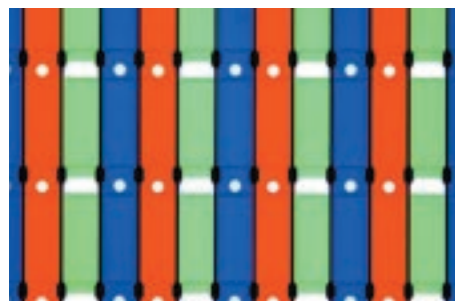

Diascopic Brightfield
LV150N LV150NA LV100ND LV100DA-U

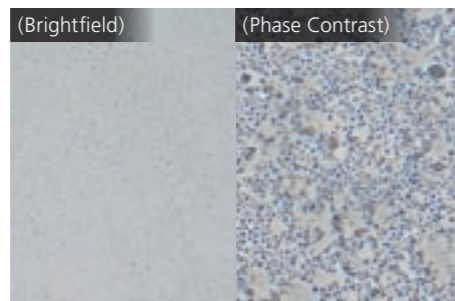

Phase Contrast
LV150N LV150NA LV100ND LV100DA-U

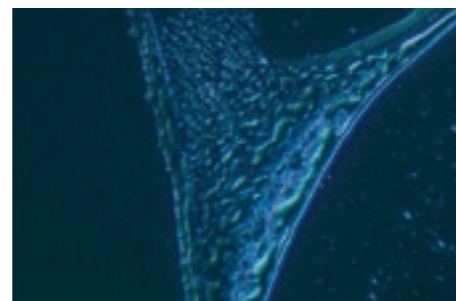

Diascopic DIC
LV150N LV150NA LV100ND LV100DA-U

LCD (color filter)

The LV-N Series is effective in the observation of samples with transparency, such as optical components, FPDs, and slide glass samples. When used in conjunction with the C-SP Simple Polarizer and analyzers, transmitted simple polarized observation is possible.

Emulsion

Colorless, transparent samples can be made visible through bright/dark contrast and the use of diffraction and interference, two properties of light.

Nanoparticle (silver)

Colorless, transparent samples can be observed in three dimensions by using polarization to create interference between two beams of light.





Specifications



	LV150N	LV150NA	LV150NL
Base unit	Maximum sample height: 38 mm (when used with LVNU5AI U5AI nosepiece and LV-S32 3x2 stage / LV-S64 6x4 stage) * 73 mm when used with one column riser 12V50W internal power source for dimmer, coarse and fine adjustment knobs Left: coarse and fine adjustment / Right: fine adjustment, 40 mm stroke Coarse adjustment: 14 mm/turn (with torque adjustment, refocusing mechanism) Fine adjustment: 0.1 mm/turn (1 μm/graduation) Stage mounting hole intervals: 70 x 94 (fixed by 4-M4 screw)	Maximum sample height: 38 mm (when used with LV-S32 3x2 stage) * 73 mm when used with one column riser Internal LED illumination power source, coarse and fine adjustment knobs Left: coarse and fine adjustment / Right: fine adjustment, 40mm stroke Coarse adjustment: 14 mm/turn (with torque adjustment, refocusing mechanism) Fine adjustment: 0.1 mm/turn (1 μm/graduation) Stage mounting hole intervals: 70 x 94 (fixed by 4-M4 screw)	Maximum sample height: 38 mm (when used with LV-S32 3x2 stage) * 73 mm when used with one column riser Internal LED illumination power source, coarse and fine adjustment knobs Left: coarse and fine adjustment / Right: fine adjustment, 40mm stroke Coarse adjustment: 14 mm/turn (with torque adjustment, refocusing mechanism) Fine adjustment: 0.1 mm/turn (1 μm/graduation) Stage mounting hole intervals: 70 x 94 (fixed by 4-M4 screw)
Nosepieces	C-N6 ESD Sextuple Nosepiece ESD LV-NU5 Universal Quintuple Nosepiece ESD LV-NBD5 BD Quintuple Nosepiece ESD LV-NU5I Intelligent Universal Quintuple Nosepiece ESD	LV-NU5A Motorized Universal Quintuple Nosepiece ESD LV-NU5AC Motorized Universal Quintuple Nosepiece ESD	C-N6 ESD Sextuple Nosepiece ESD LV-NU5 Universal Quintuple Nosepiece ESD
Episcopic Illuminator	LV-UEPI-N LV-LH50PC 12V50W Precentered Lamphouse Bright/darkfield switch and linked aperture stop (centerable), field diaphragm (centerable) Accepts ø 25 mm filter (NCB11, ND16, ND4), polarizer/analyzer, λ plate, excitation light balancer; equipped with noise terminator LV-UEPI2 LV-LH50PC 12V50W Precentered Lamphouse HG precentered fiber illuminator: C-HGFIE (with light adjustment) *option Bright/darkfield switch and linked aperture stop (centerable), field diaphragm (centerable), automated optical element switching feature matched to brightfield, darkfield, and epi-fluorescence switch Accepts ø 25 mm filter (NCB11, ND16, ND4), polarizer/analyzer, λ plate, excitation light balancer; equipped with noise terminator	1.1W white LED Accepts polarizer/analyzer	
Eyepiece tubes	LV-TI3 trinocular eyepiece tube ESD (Erected image, FOV: 22/25) LV-TT2 TT2 tilting trinocular eyepiece tube (Erected image, FOV: 22/25) C-TB binocular tube (Inverted image, FOV: 22) P-TB Binocular Tube (Inverted image, FOV: 22) P-TT2 Trinocular Tube (Inverted image, FOV: 22)	LV-TI3 trinocular eyepiece tube ESD (Erected image, FOV: 22/25) C-TB binocular tube (Inverted image, FOV: 22) P-TB Binocular Tube (Inverted image, FOV: 22) P-TT2 Trinocular Tube (Inverted image, FOV: 22)	LV-TI3 trinocular eyepiece tube ESD (Erected image, FOV: 22/25) C-TB binocular tube (Inverted image, FOV: 22) P-TB Binocular Tube (Inverted image, FOV: 22) P-TT2 Trinocular Tube (Inverted image, FOV: 22)
Stages	LV-S32 3x2 stage (Stroke: 75 x 50 mm with glass plate) ESD compatible LV-S64 6x4 stage (Stroke: 150 x 100 mm with glass plate) ESD compatible LV-S6 6x6 stage (Stroke: 150 x 150 mm) ESD compatible	LV-S32 3x2 stage (Stroke: 75 x 50 mm with glass plate) ESD compatible LV-S6 6x6 stage (Stroke: 150 x 150 mm) ESD compatible	LV-S32 3x2 stage (Stroke: 75 x 50 mm with glass plate) ESD compatible LV-S6 6x6 stage (Stroke: 150 x 150 mm) ESD compatible
Eyepieces	CFI eyepiece series		
Objective lenses	Industrial Microscope CFI ₆₀ -2/CFI ₆₀ optical system Objective lens series: Combinations in accordance with the observation method		
ESD performance	1,000 to 10V, within 0.2 sec. (excluding certain accessories)		
Power consumption	1.2 A / 75 W		0.1A / 3W
Weight	Approx. 8.6 kg	Approx. 8.7 kg	Approx. 8.6 kg

	LV100ND	LV100DA-U
Base unit	Maximum sample height: 38 mm (when used with LVNU5AI U5AI nosepiece and LV-S32 3x2 stage / LV-S64 6x4 stage) 12V50W internal power source for dimmer, coarse and fine adjustment knobs Left: coarse and fine adjustment / Right: fine adjustment, 40 mm stroke Coarse adjustment: 14 mm/turn (with torque adjustment, refocusing mechanism) Fine adjustment: 0.1 mm/turn (1 μm/graduation)	Maximum sample height: 33 mm (when used with LVNU5AI U5AI nosepiece and LV-S32 3x2 stage / LV-S64 6x4 stage) 12V50W internal power source for dimmer, coarse and fine adjustment knobs Left: coarse and fine adjustment / Right: fine adjustment, 40 mm stroke Coarse adjustment: 14 mm/turn (with torque adjustment, refocusing mechanism) Fine adjustment: 0.1 mm/turn (1 μm/graduation)
Nosepieces	C-N6 ESD Sextuple Nosepiece ESD, LV-NU5 Universal Quintuple Nosepiece ESD, LV-NBD5 BD Quintuple Nosepiece ESD, LV-NU5I Intelligent Universal Quintuple Nosepiece ESD, D-ND6 Sextuple DIC Nosepiece	LV-NU5AI Motorized Universal Quintuple Nosepiece (High-durability motorized 5-hole universal nosepiece)
Episcopic Illuminators	LV-UEPI-N LV-LH50PC 12V50W Precentered Lamphouse Bright/darkfield switch and linked aperture stop (centerable), field diaphragm (centerable), accepts ø 25 mm filter (NCB11, ND16, ND4), polarizer/analyzer; equipped with noise terminator LV-UEPI2 LV-LH50PC 12V50W Precentered Lamphouse HG precentered fiber illuminator: C-HGFIE (with light adjustment) *option Bright/darkfield switch and linked aperture stop (centerable), field diaphragm (centerable), automated optical element switching feature matched to brightfield, darkfield, and epi-fluorescence switch Accepts ø 25 mm filter (NCB11, ND16, ND4), polarizer/analyzer, λ plate, excitation light balancer; equipped with noise terminator	LV-UEPI2A LV-LH50PC 12V50W Precentered Lamphouse HG precentered fiber illuminator: C-HGFIE (with light adjustment: PC controlled) *option Motorized operation and control of illumination selector turret Motorized aperture stop linked to bright/darkfield selector (automatic optimization matched to objective lens), field diaphragm (centerable) Accepts ø 25 mm filter (NCB11, ND16, ND4), polarizer/analyzer, λ plate, excitation light balancer; equipped with noise terminator
Diascopic Illuminator	LV-LH50PC 12V50W Precentered Lamphouse (Fly Eye optical system) Internal aperture, field diaphragm, filter (ND8, NCB11); transmitted/reflected selector switch; 12V100W also available (option)	
Eyepiece tubes	LV-TI3 trinocular eyepiece tube ESD (Erected image, FOV: 22/25), LV-TT2 TT2 tilting trinocular eyepiece tube (Erected image, FOV: 22/25), P-TB Binocular Tube (Inverted image, FOV: 22), P-TT2 Trinocular Tube (Inverted image, FOV: 22)	
Stages	LV-S32 3x2 stage (Stroke: 75 x 50 mm with glass plate) / LV-S32SGH slide glass holder LV-S64 6x4 stage (Stroke: 150 x 100 mm with glass plate), LV-SRP P revolving stage / P-GS2 revolving stage: Used with stage adapter LV-SAD NIU-CSRR2 Ni-U right handle rotatable ceramic stage (Stroke: 78 x 54 mm), C-SR2S right handle stage (Stroke: 78 x 54 mm: Used with stage adapter LV-SAD)	
Condensers	LWD achromat condenser (brightfield), LV-CUD U condenser dry (phase contrast, diascopic DIC, darkfield), Achromat 2x-100x slide condenser (brightfield), DF dry condenser (darkfield), and others	
Eyepieces	CFI eyepiece series	
Objective lenses	Industrial Microscope CFI ₆₀ -2/CFI ₆₀ optical system Objective lens series: Combinations in accordance with the observation method	
ESD performance	1,000 to 10V, within 0.2 sec. (excluding certain accessories)	
Power consumption	1.2 A / 75 W	1.2 A / 90 W
Weight	Approx. 9.5 kg	Approx. 10 kg

Lens Specifications

Dimensions

	Type	Model	Magnification	Product Code No.	NA	Working Distance (mm)
CFI60-2	Brightfield	T Plan EPI	1x	MUE12010	0.03	3.8
		Plan (Semi-apochromat)	2.5x	MUE12030	0.075	6.5
		TU Plan Fluor EPI	5x	MUE12050	0.15	23.5
		Universal Plan Fluor (Semi-apochromat)	10x	MUE12100	0.3	17.5
			20x	MUE12200	0.45	4.5
			50x	MUE12500	0.8	1.0
			100x	MUE12900	0.9	1.0
		TU Plan Apo EPI	50x	MUC11500	0.8	2.0
		Universal Plan Apo (Apochromat) 	100x	MUC11900	0.9	2.0
		* Scheduled for sale from January 2013.	150x	MUC11150	0.9	1.5
	Polarizing	TU Plan Fluor EPI P	5x	MUE13050	0.15	23.5
		Polarizing Universal Plan Fluor (Semi-apochromat)	10x	MUE13100	0.3	17.5
			20x	MUE13200	0.45	4.5
			50x	MUE13500	0.8	1.0
			100x	MUE13900	0.9	1.0
	Brightfield Long Working Distance	TU Plan EPI ELWD	20x	MUE21200	0.4	19.0
		Long Working Distance Universal Plan (Semi-apochromat) 	50x	MUE21500	0.6	11.0
			100x	MUE21900	0.8	4.5
	Brightfield Super-long Working Distance	T Plan EPI SLWD	10x	MUE31100	0.2	37.0
		Super-long Working Distance Plan (Semi-apochromat) 	20x	MUE31200	0.3	30.0
		50x	MUE31500	0.4	22.0	
		100x	MUE31900	0.6	10.0	
Brightfield/Darkfield	TU Plan Fluor BD	5x	MUE42050	0.15	18.0	
	Universal Plan Fluor (Semi-apochromat)	10x	MUE42100	0.3	15.0	
		20x	MUE42200	0.45	4.5	
		50x	MUE42500	0.8	1.0	
		100x	MUE42900	0.9	1.0	
	TU Plan Apo BD	50x	MUC41500	0.8	2.0	
	Universal Plan Apo (Apochromat) 	100x	MUC41900	0.9	2.0	
* Scheduled for sale from January 2013.	150x	MUC41150	0.9	1.5		
Brightfield/Darkfield Long Working Distance	TU Plan BD ELWD	20x	MUE61200	0.4	19.0	
	Long Working Distance Universal Plan (Semi-apochromat) 	50x	MUE61500	0.6	11.0	
		100x	MUE61900	0.8	4.5	

 : Phase Fresnel lens (diffraction optical element) type •  A circular polarizing plate and depolarizer are built into T Plan EPI 1x/2.5x. (Circular polarizing plate can be attached/detached.)

	Type	Model	Magnification	Product Code No.	NA	Working Distance (mm)
CFI60	Brightfield With Correction Mechanism	L Plan EPI CR	20x	MUE35200	0.45	10.9 - 10.0
		For Inspecting LCDs Plan	50x	MUE35500	0.7	3.9 - 3.0
			100x	MUE35900	0.85	1.2 - 0.85
			100x	MUE35910	0.85	1.3 - 0.95
	Brightfield	L Plan EPI Plan (Achromat)	40x	MUE00400	0.65	1.0
	Brightfield Super-long Working Distance	LU Plan EPI SLWD	20x	MUE30201	0.35	24.0
		Super-long Working Distance Plan (Achromat)	50x	MUE30501	0.45	17.0
			100x	MUE30901	0.7	6.5
	Brightfield	LU Plan Apo EPI	100x	MUC00090	0.95	0.4
		Universal Plan Apo (Apochromat)	150x	MUC10151	0.95	0.3
Brightfield/Darkfield	LU Plan Apo BD	100x	MUC40900	0.9	0.51	
	Universal Plan Apo (Apochromat)	150x	MUC50151	0.9	0.42	
CF&IC	Interferometry	CF IC EPI Plan TI	2.5x	MUL42031	0.075	10.3
		For Interferometry Plan	5x	MUL42051	0.13	9.3
		CF IC EPI Plan DI	10x	MUL40101	0.3	7.4
		For Two-beam Interferometry Plan	20x	MUL40201	0.4	4.7
		50x	MUL40501	0.55	3.4	
		100x	MUL40900	0.7	2.0	
Brightfield	CF IC EPI Plan Apo	50x	MUT10051	0.95	0.4	
	Plan Apochromat	100x	MUT10101	0.95	0.3	
		150x	MUT10153	0.95	0.2	

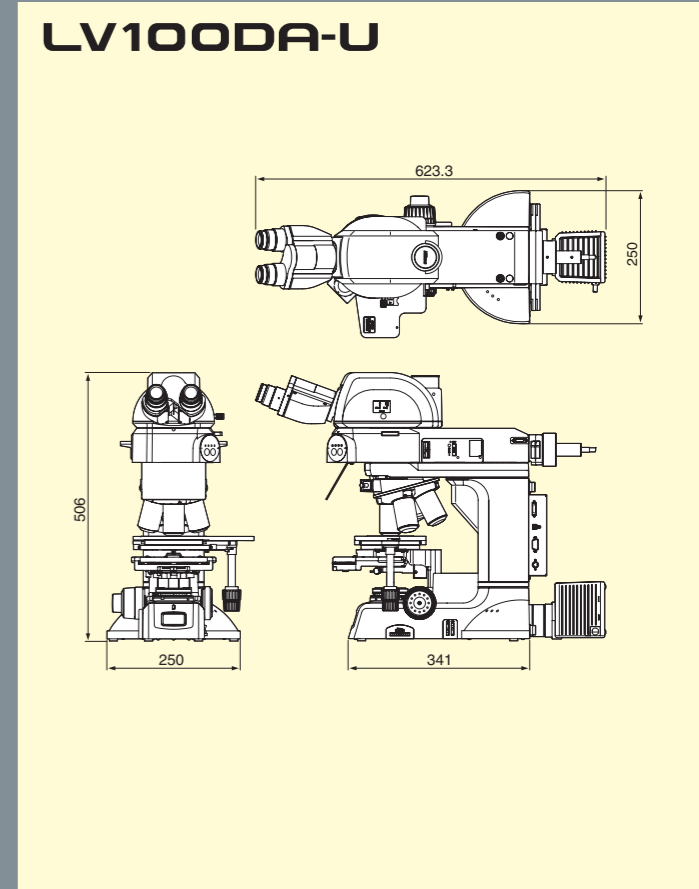
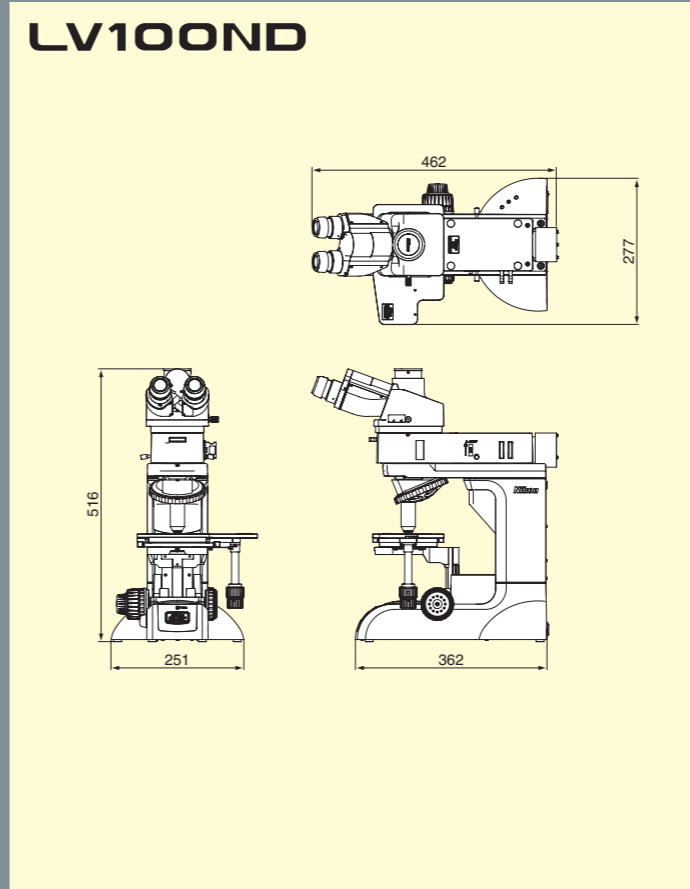
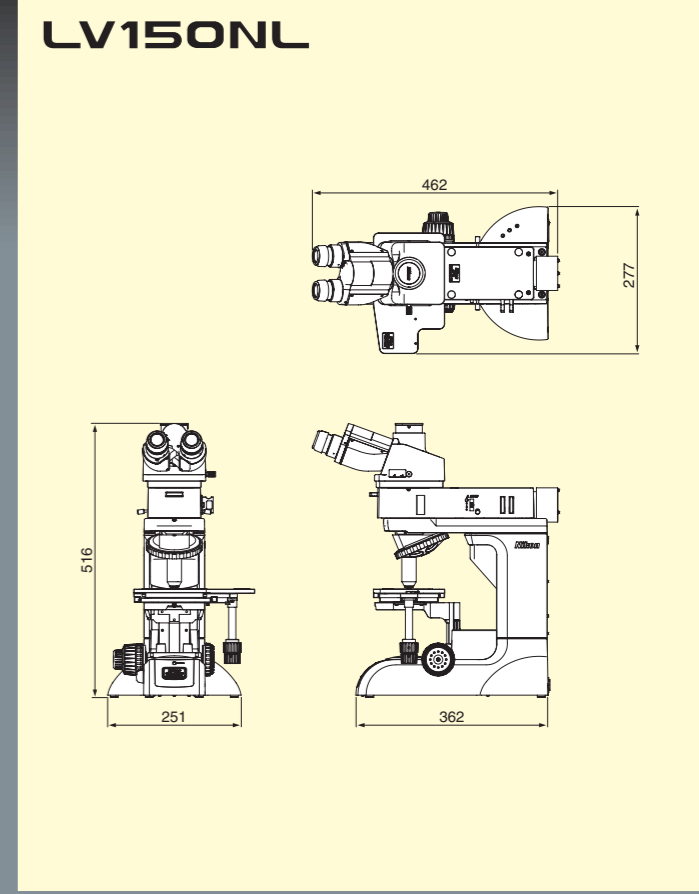
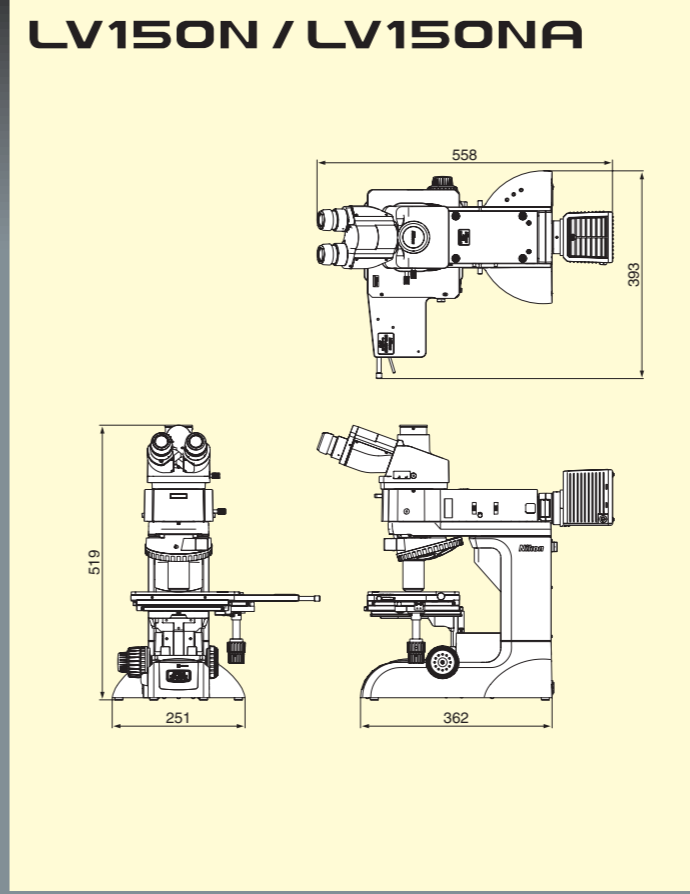

System Diagram

for LV150N/LV150ND/LV100NDA/LV100DA-U

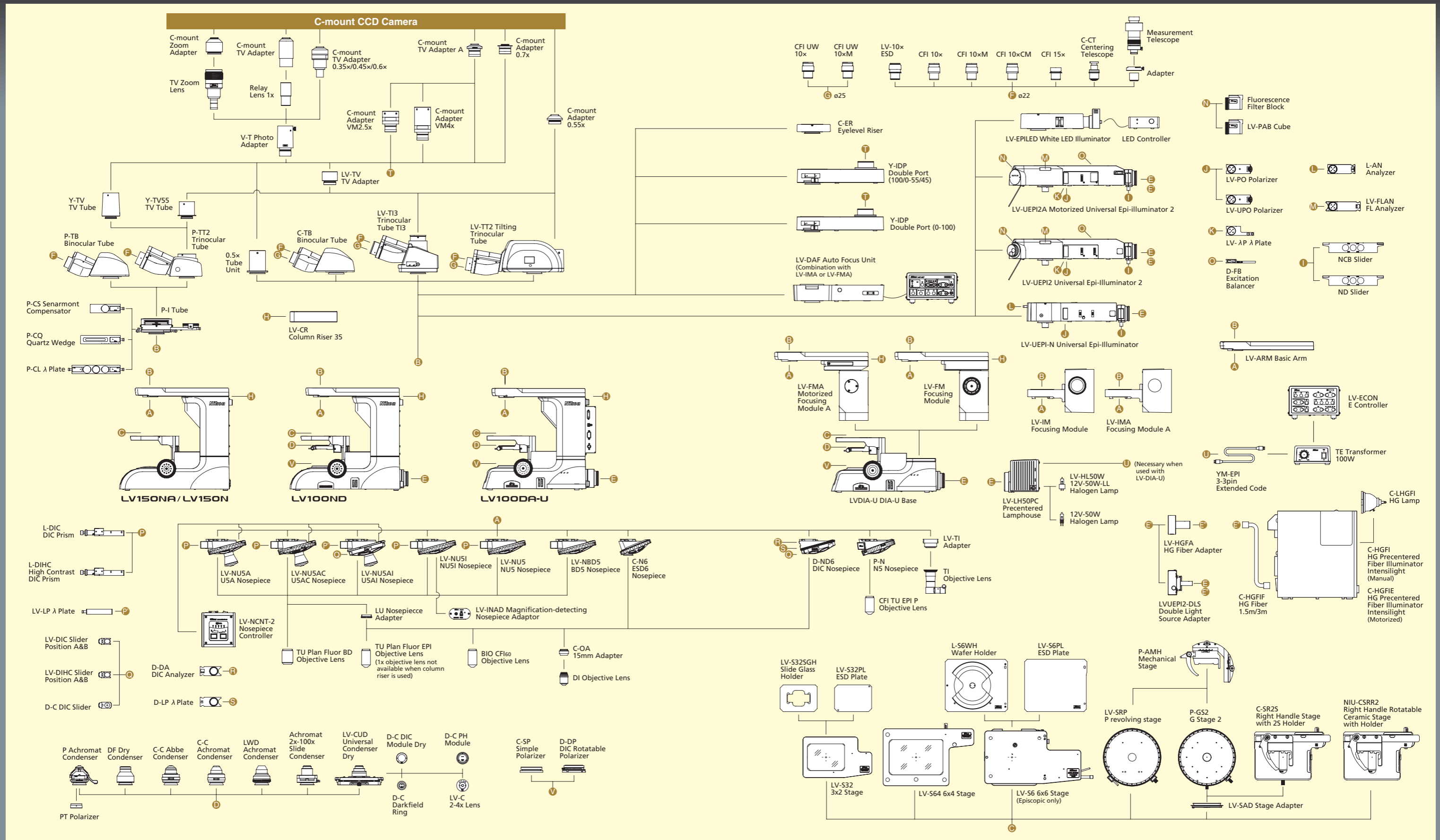

System Diagram

for LV150NL

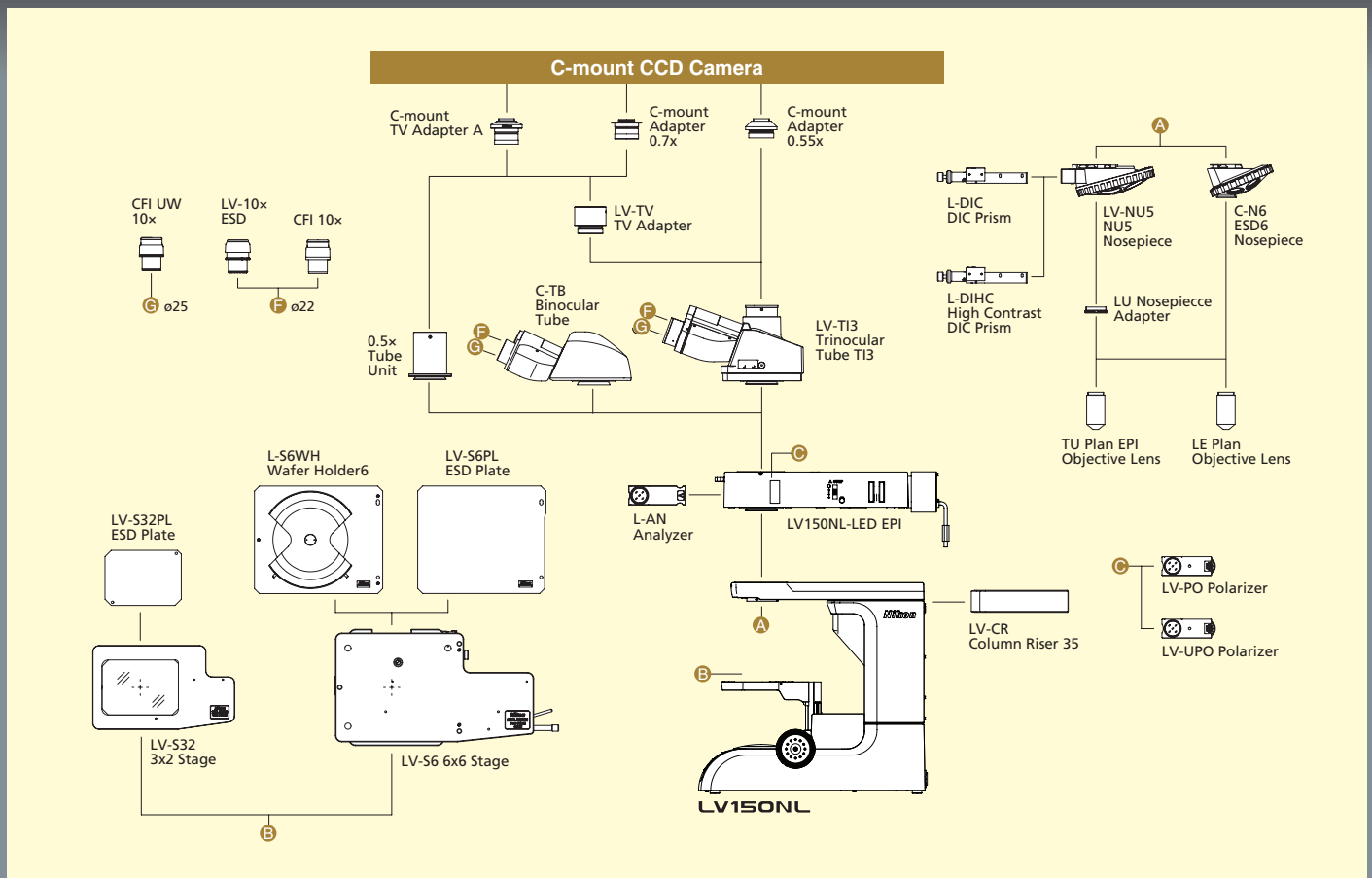

Specifications and equipment are subject to change without any notice or obligation on the part of the manufacturer. December 2012 ©2012 NIKON CORPORATION

N.B. Export of the products* in this catalog is controlled under the Japanese Foreign Exchange and Foreign Trade Law. Appropriate export procedures shall be required in case of export from Japan.

*Products: Hardware and its technical information (including software)

WARNING TO ENSURE CORRECT USAGE, READ THE CORRESPONDING MANUALS CAREFULLY BEFORE USING THE EQUIPMENT.



NIKON CORPORATION

Shin-Yurakucho Bldg., 12-1, Yurakucho 1-chome
Chiyoda-ku, Tokyo 100-8331 Japan
phone: +81-3-3216-2384 fax: +81-3-3216-2388
<http://www.nikon.com/instruments/>



ISO 9001 Certified
for NIKON CORPORATION
Instruments Company



ISO 14001 Certified
for NIKON CORPORATION
Yokohama Plant

NIKON METROLOGY, INC.

12701 Grand River Avenue, Brighton, MI 48116 U.S.A.
phone: +1-810-220-4360 fax: +1-810-220-4300
E-mail: sales_us@nikonmetrology.com
<http://us.nikonmetrology.com/>
<http://www.nikoninstruments.com/>

NIKON METROLOGY EUROPE NV

Geldenaaksebaan 329, 3001 Leuven, Belgium
phone: +32-16-74-01-00 fax: +32-16-74-01-03
Email: sales_europe@nikonmetrology.com
<http://www.nikonmetrology.com/>

NIKON INSTRUMENTS (SHANGHAI) CO., LTD.

CHINA phone: +86-21-6841-2050 fax: +86-21-6841-2060
(Beijing branch) phone: +86-10-5831-2028 fax: +86-10-5831-2026
(Guangzhou branch) phone: +86-20-3882-0550 fax: +86-20-3882-0580

NIKON SINGAPORE PTE LTD.

SINGAPORE phone: +65-6559-3618 fax: +65-6559-3668

NIKON MALAYSIA SDN. BHD.

MALAYSIA phone: +60-3-7809-3688 fax: +60-3-7809-3633

NIKON INSTRUMENTS KOREA CO., LTD.

KOREA phone: +82-2-2186-8400 fax: +82-2-555-4415

NIKON INDIA PRIVATE LIMITED

INDIA phone: +91-124-4688500 fax: +91-124-4688527

NIKON CANADA INC.

CANADA phone: +1-905-602-9676 fax: +1-905-602-9953

NIKON INSTRUMENTS S.p.A.

ITALY phone: +39-055-300-96-01 fax: +39-055-30-09-93

NIKON METROLOGY UK LTD.

UNITED KINGDOM phone: +44-1332-811-349 fax: +44-1332-639-881

E-mail: sales_uk@nikonmetrology.com

NIKON METROLOGY SARL

FRANCE phone: +33-1-60-86-09-76 fax: +33-1-60-86-57-35

E-mail: sales_france@nikonmetrology.com

NIKON METROLOGY GMBH

GERMANY phone: +49-6023-91733-0 fax: +49-6023-91733-229

E-mail: sales_germany@nikonmetrology.com