



NeoScope

JCM-6000Plus



N.B. Export of the products* in this catalog is controlled under the Japanese Foreign Exchange and Foreign Trade Law. Appropriate export procedure shall be required in case of export from Japan.

*Products: Hardware and its technical information (including software)

Specifications and equipment are subject to change without any notice or obligation on the part of the manufacturer. September 2015
©2007-15 NIKON CORPORATION

	WARNING	TO ENSURE CORRECT USAGE, READ THE CORRESPONDING MANUALS CAREFULLY BEFORE USING YOUR EQUIPMENT.
--	----------------	--



NIKON CORPORATION

Shinagawa Intercity Tower C, 2-15-3, Konan, Minato-ku, Tokyo 108-6290, Japan
phone: +1-631-547-8500; +1-800-52-NIKON (within the U.S.A. only)
fax: +1-631-547-0306
<http://www.nikon.com/instruments/>



ISO 9001 Certified
for NIKON CORPORATION
Microscope Solutions Business Unit
Industrial Metrology Business Unit



ISO 14001 Certified
for NIKON CORPORATION

NIKON INSTRUMENTS INC.

1300 Walt Whitman Road, Melville, N.Y. 11747-3064, U.S.A.
phone: +1-631-547-8500; +1-800-52-NIKON (within the U.S.A. only)
fax: +1-631-547-0306
<http://www.nikoninstruments.com/>

NIKON METROLOGY, INC.

12701 Grand River Avenue, Brighton, MI 48116 U.S.A.
phone: +1-810-220-4360 fax: +1-810-220-4300
E-mail: Sales.US.NM@nikon.com
<http://us.nikonmetrology.com/>
<http://www.nikoninstruments.eu/>

NIKON INSTRUMENTS EUROPE B.V.

Tripolis 100, Burgerweeshuispad 101, 1076 ER Amsterdam, The Netherlands
phone: +31-20-7099-000 fax: +31-20-7099-298
<http://www.nikoninstruments.eu/>

NIKON METROLOGY EUROPE NV

Geldenaaksebaan 329, 3001 Leuven, Belgium
phone: +32-16-74-01-00 fax: +32-16-74-01-03
E-mail: Sales.Europe.NM@nikon.com
<http://www.nikonmetrology.com/>

NIKON INSTRUMENTS (SHANGHAI) CO., LTD.

CHINA phone: +86-21-6841-2050 fax: +86-21-6841-2060
(Beijing branch) phone: +86-10-5831-2028 fax: +86-10-5831-2026
(Guangzhou branch) phone: +86-20-3882-0552 fax: +86-20-3882-0580

NIKON SINGAPORE PTE LTD

SINGAPORE phone: +65-6559-3618 fax: +65-6559-3668

NIKON MALAYSIA SDN BHD

MALAYSIA phone: +60-3-7809-3688 fax: +60-3-7809-3633

PT. NIKON INDONESIA

INDONESIA phone: +62-21-574-6262 fax: +62-21-574-6363

NIKON SALES (THAILAND) CO., LTD.

THAILAND phone: +66-2633-5100 fax: 66-2633-5191

NIKON INSTRUMENTS KOREA CO., LTD.

KOREA phone: +82-2-2186-8400 fax: +82-2-555-4415

NIKON INDIA PRIVATE LIMITED

INDIA phone: +91-124-4688500 fax: +91-124-4688527

NIKON INSTRUMENTS S.p.A.

ITALY phone: +39-55-300-96-01 fax: +39-55-30-09-93

NIKON GMBH AUSTRIA

AUSTRIA phone: +43-1-972-6111-00 fax: +43-1-972-6111-40

NIKON UK LTD.

UNITED KINGDOM phone: +44-208-247-1717 fax: +44-208-541-4584

NIKON METROLOGY UK LTD.

UNITED KINGDOM phone: +44-1332-811-349 fax: +44-1332-639-881
E-mail: Sales.UK.NM@nikon.com

NIKON FRANCE S.A.S.

FRANCE phone: +33-1-4516-45-16 fax: +33-1-4516-45-55

NIKON METROLOGY SARL

FRANCE phone: +33-1-60-86-09-76 fax: +33-1-60-86-57-35

E-mail: Sales.France.NM@nikon.com

NIKON GMBH

GERMANY phone: +49-211-941-42-20 fax: +49-211-941-43-22

NIKON METROLOGY GMBH

GERMANY phone: +49-6023-91733-0 fax: +49-6023-91733-229

E-mail: Sales.Germany.NM@nikon.com



Solutions for Innovation

JCM-6000Plus

JCM-6000Plus is a full-fledged benchtop SEM with versatile functions.

Operation via touch panel simplifies execution from observation to analysis.

Stylish appearance, compact and lightweight allows for installation in small spaces.



The Most Advanced Benchtop

NeoScope

JCM-6000Plus



SEM



Features

Simple operation

Advanced capabilities

High-vacuum/Low-vacuum modes

Image search

Metrology

A wealth of options

Elemental analysis

Motor drive stage

Quick response

Easy installation and maintenance



Easy Observation



Sample: Iron rust

Touch panel & Keyboard/Mouse Operation

All controls are at your fingertips. Use the multi-touch monitor or keyboard/mouse for flexible and intuitive operation.

Automated functions

Auto controls include alignment, focus, stigmator, contrast/brightness, and Full Auto. A single touch of Full Auto will initiate the entire imaging process to present an image instantly.

Manual control

An item touched and selected will turn green.

Hard, continued pressing of the buttons for coarse control. Light, intermittent tapping for fine control.

Image search/display

The Display image button is used to search a library of images. Checking the Display image button after selecting a desired image will present a magnified view for closer examination.

Minimum magnification image

Checking the Low Mag Image will allow the operator to view an image acquired at the lowest magnification immediately after the evacuation sequence is completed. This is a useful feature when positioning the sample.

Preset magnification

Up to 6 magnifications can be preset. Programming frequently used magnifications will increase operating efficiency. One of the buttons can be used to preset the current magnification.



Advanced capabilities

01

Observe

Switch between High-vacuum mode and Low-vacuum mode with a single mouse click. A wide variety of sample types can be easily observed.

High-vacuum mode: SEI

High-vacuum mode provides secondary electron image (SEI) and backscattered electron image (BEI). SEI reveals fine structure on sample surfaces. In addition, SEI facilitates high magnification observation.

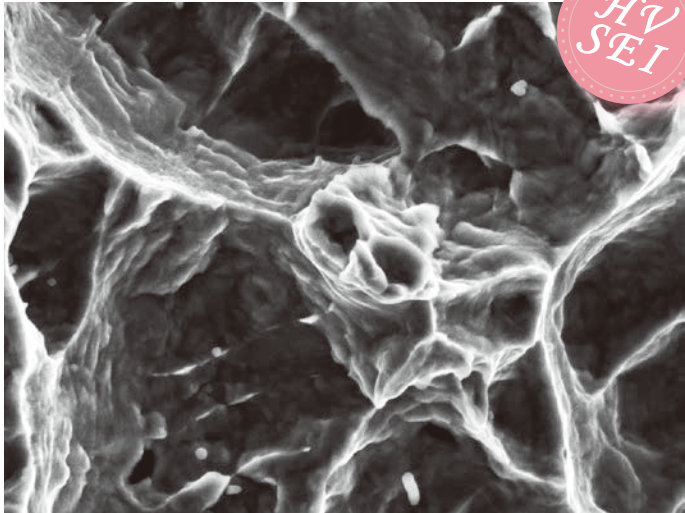

Sample: Metal fracture surface
Accelerating voltage 15 kV, magnification $\times 5,000$

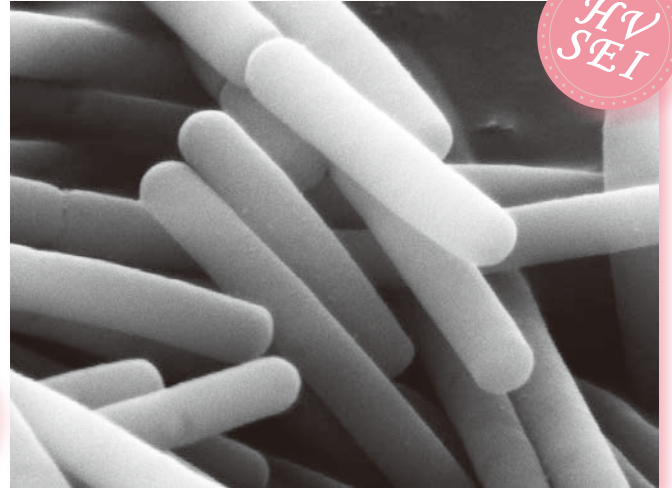

Sample: Yogurt culture
Accelerating voltage 15 kV, magnification $\times 20,000$

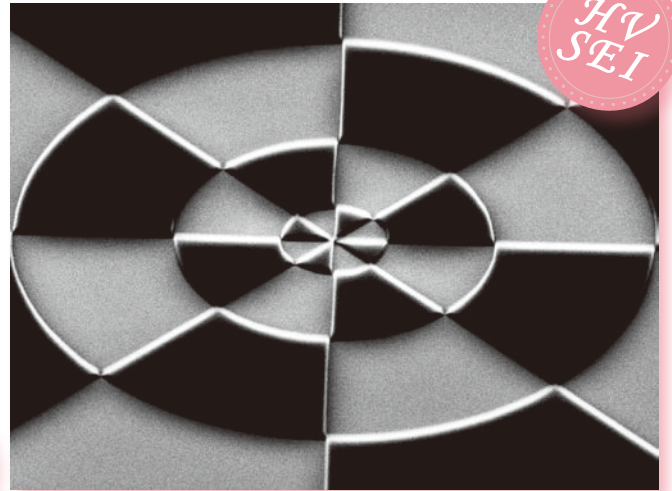

Sample: Patterns on Si
Accelerating voltage 15 kV, magnification $\times 5,000$

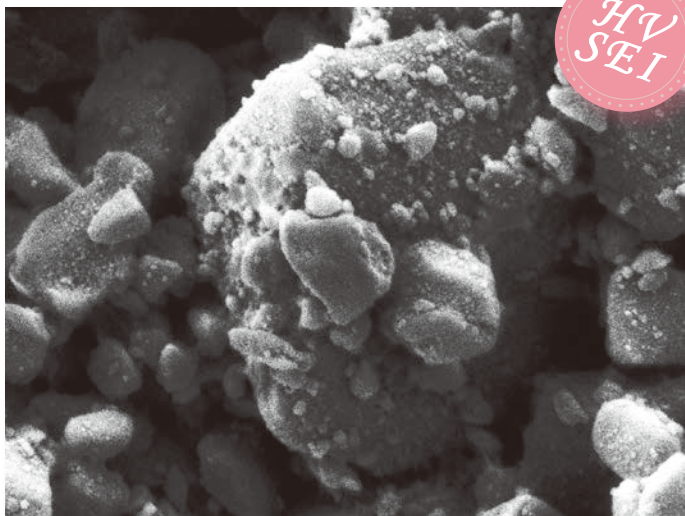

Sample: Coated paper
Accelerating voltage 5 kV, magnification $\times 5,000$



Sample: Mouse trachea
Accelerating voltage 15 kV, magnification $\times 10,000$

High-vacuum mode: BEI

A semiconductor backscattered electron detector enables acquisition of three kinds of BEI information: composition image, Combination with SEI allows the operator to obtain complimentary information.

Sample: Sand eraser
Accelerating voltage 15 kV, magnification $\times 1,500$

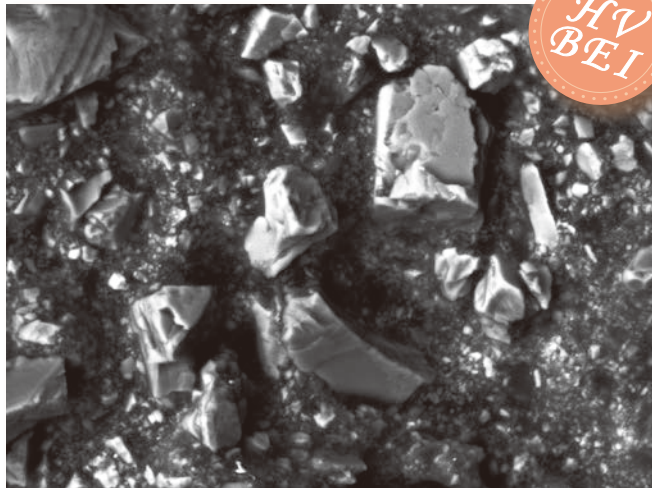

BEI stereomicroscopic image 20 μ m

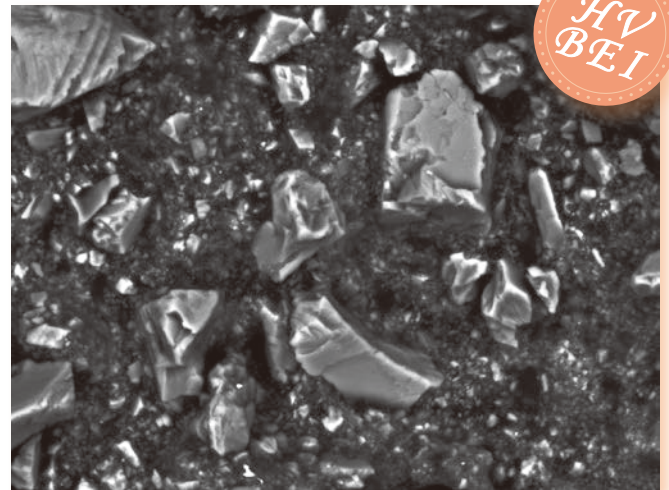

BEI composition image 20 μ m

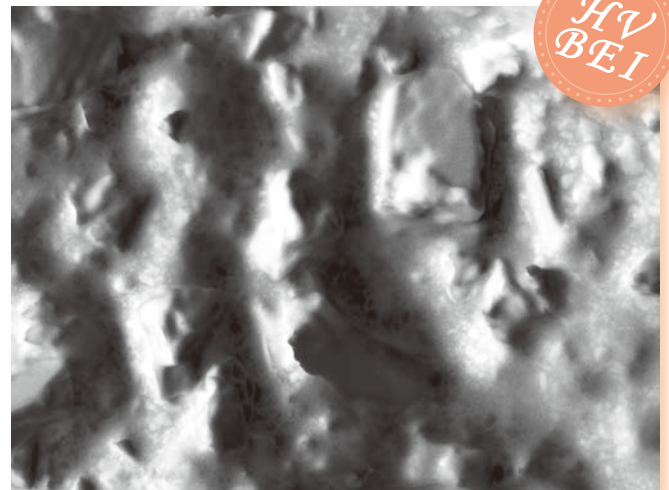

BEI topographic image 20 μ m

Low-vacuum mode

JCM-6000Plus includes Low-vacuum mode, which raises the pressure in the specimen chamber to neutralize the charging of sample surfaces for enabling observation of non-conductive samples. Low-vacuum mode also allows the operator to easily observe wet, oily or out-gassing samples with minimal sample preparation.



Sample: Paper
Accelerating voltage 15 kV, magnification $\times 550$ 50 μ m



Sample: Petal (Ageratum)
Accelerating voltage 15 kV, magnification $\times 100$ 200 μ m



02

Search and print

Search image window

The search image window allows the operator to select and print image data. This window also allows the operator to restore the imaging conditions for any stored image.

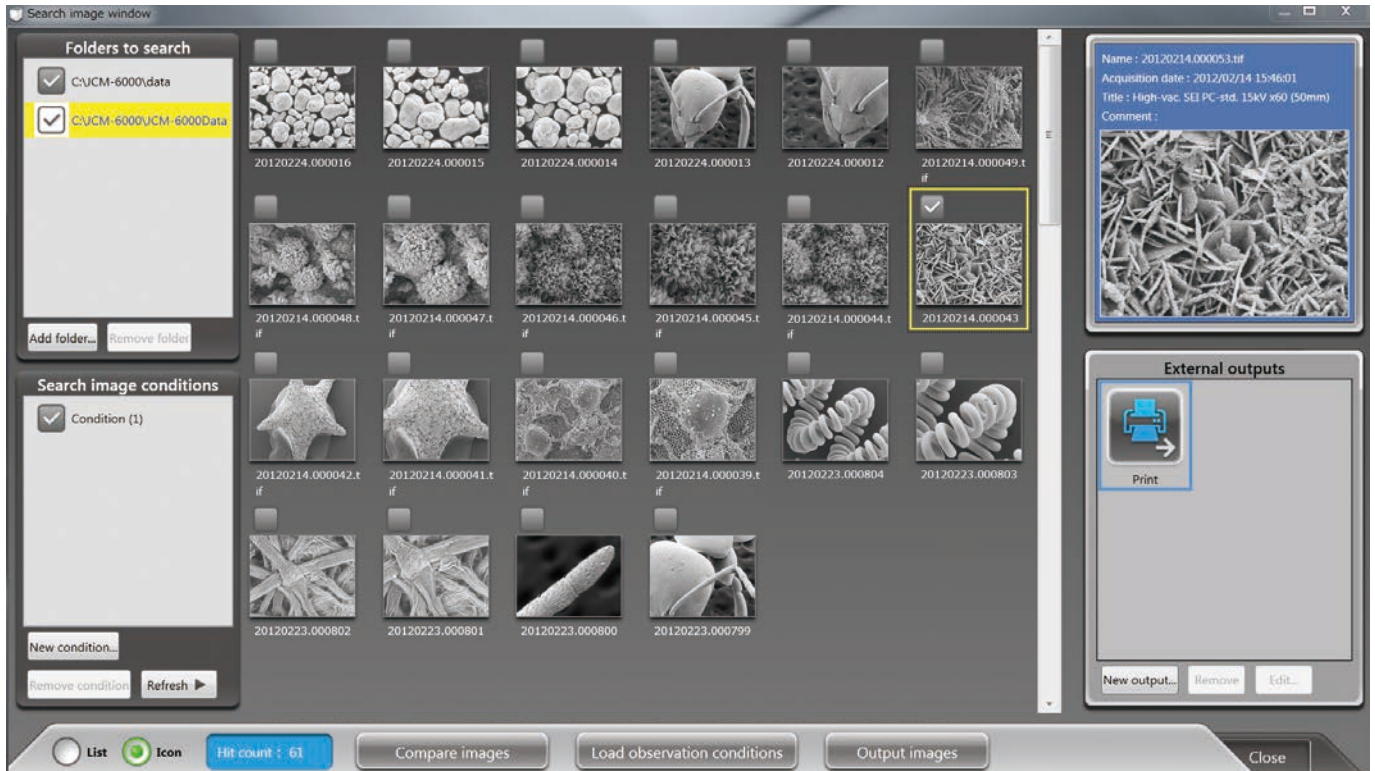

Search image window

Print

Selecting a desired image and pressing the Output images button in the Search image window will display a preview image. If multiple images are selected, the system will automatically print 3 images per page.

Retrieve imaging conditions

NeoScope can retrieve the imaging conditions of any image that is saved in memory. The system will retrieve the data when an image is selected and the Load observation conditions button is pressed. It is a convenient feature for routine operation.

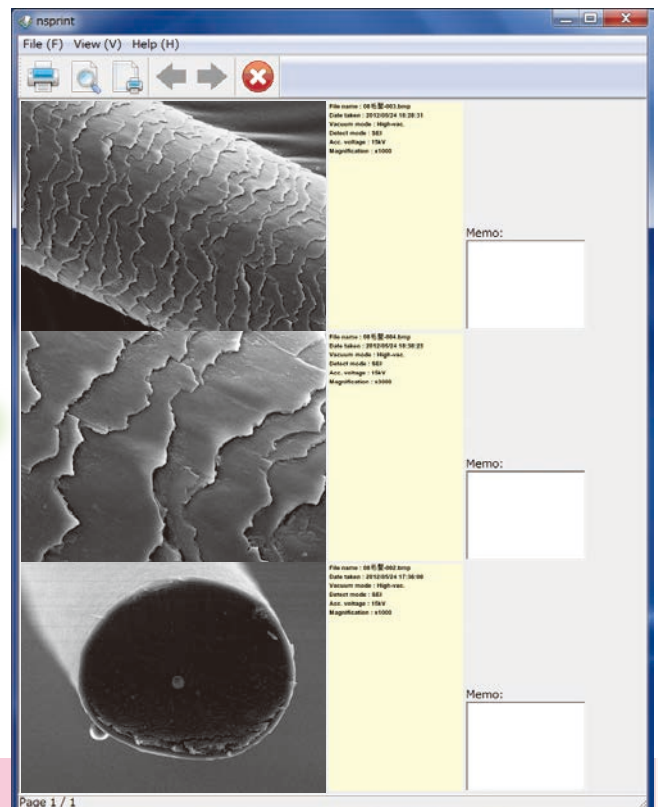

Print view

Sample: Human hair

03 Compare

Dual frame display

NeoScope can simultaneously display live and Stored images. In the example below, a low magnification image is presented on the right while a live image is on. This allows the operator to compare a current image with another image retrieved from memory.

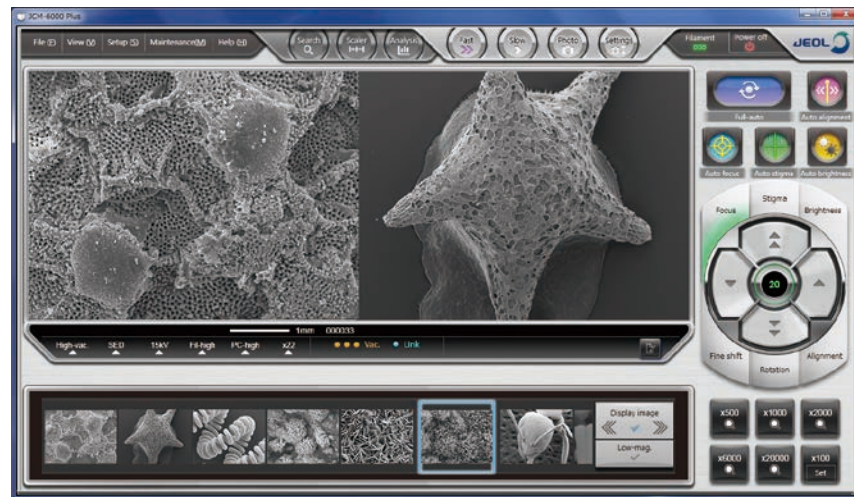

Sample: Star sand

04 Movie observation

Movie

JCM-6000Plus can acquire a movie. This capability allows observation of dynamic motions.

Movies of live image are useful for observation of changes in sample with time.



05 Measure

Metrology



Measurement function is built in. When the Scaler button is selected, measure the distance between 2 points. The measured results can be saved on the image as well as output as a CSV data file.



Sample: Metal particles



No.	Length	[unit]	Angle[deg]
1	5.79	um	44
2	5.47	um	12
3	6.12	um	89
4	5.54	um	41

A wealth of options

OPTION

01 Elemental analysis

EDS

Pressing the Analysis button will open the EDS view. EDS supports qualitative/quantitative analysis, point analysis, and mapping (elemental distribution).

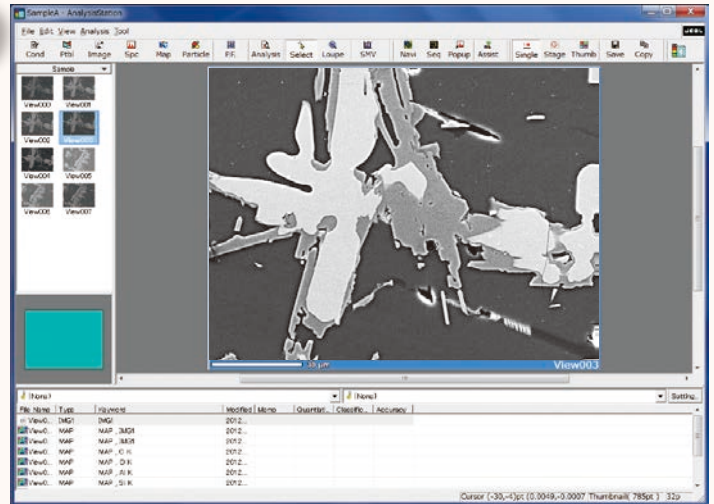

Sample: Black ore (mineral)

Qualitative/Quantitative analysis

Two buttons, Image and Spc, initiate analysis. Pressing the Quantitative button after data acquisition will display quantitative results.

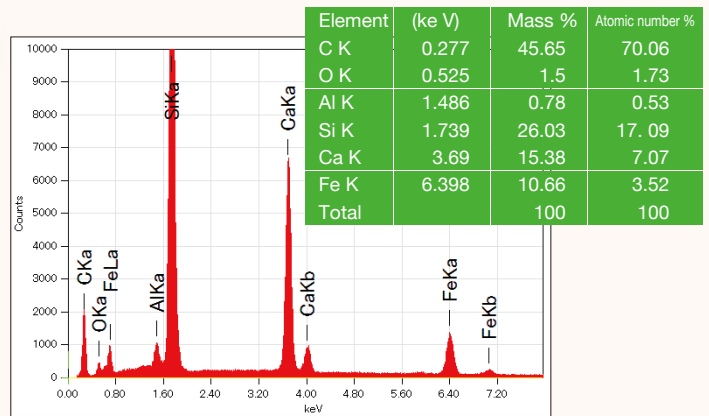
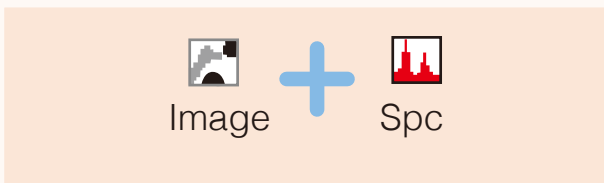

Mapping (elemental distribution)

Pressing the Map button will initiate active hyper spectral mapping showing the distribution of the constituent elements.

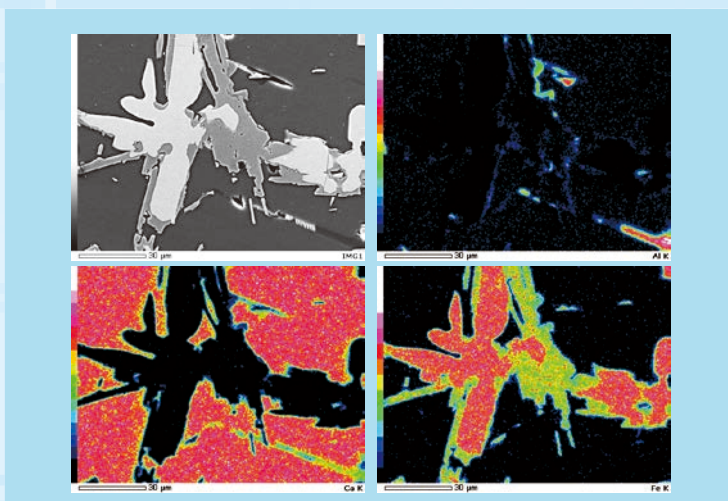

Using mapped results, the operator can:

- Create **quantitative maps** in color where each color represents the quantitative value of an element.
- **Reconstruct maps** of additional elements.
- Select a specific area on the map and extract the **spectrum**
- Overlap **elemental maps** and identify where the elements of interest exist in the area of view or how they are overlapped.

Analysis Assistant

Step-by-step guide to help navigate any data acquisition process including mapping and line scans.

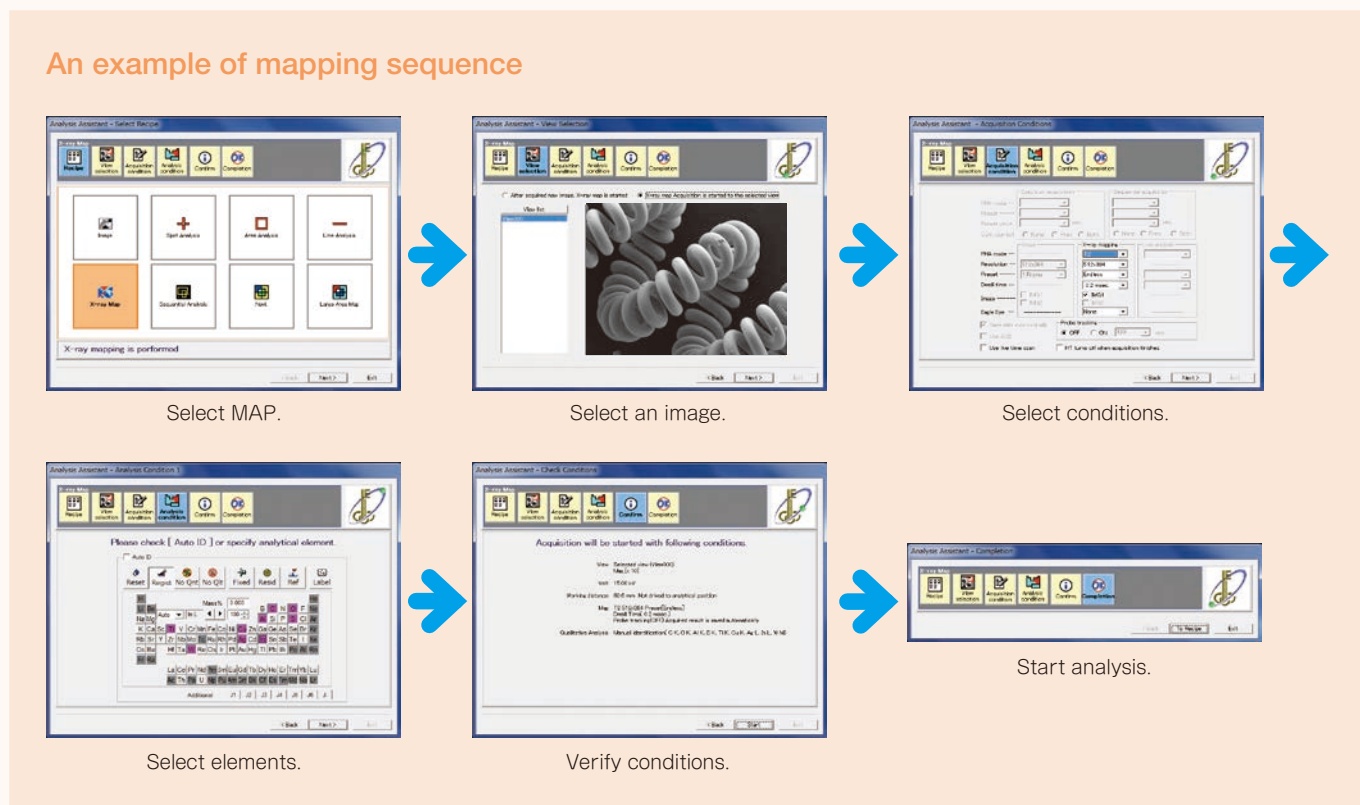

Point analysis

When multiple analytical points are selected on the image, the system will automatically analyze each point and display spectral data. These spectra can be compared after the analysis is completed.

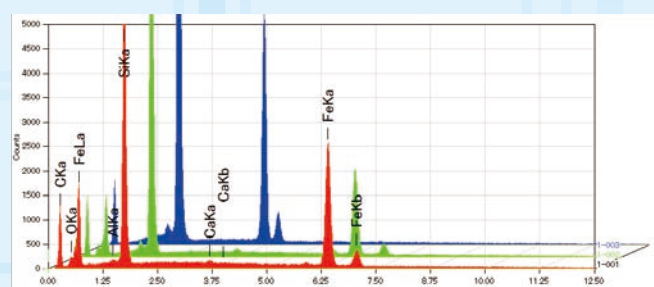
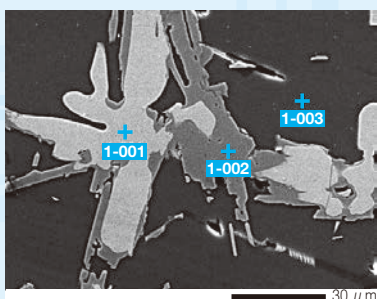

Line Scan

When a line is defined on the image, the system will begin measuring relative concentration changes in the elements identified along the line. The elements may be edited after the analysis is completed.

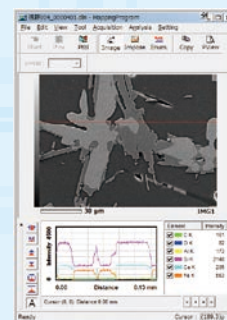

Probe tracking

Probe tracking is designed to maintain a stable analytical point with prolonged operation.

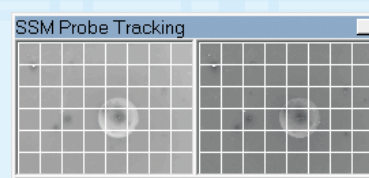

02 Motor drive stage

OPTION

Motor drive stage

The motor drive stage enhances throughput by fast positioning to the area of interest. The specimen holder is graphically displayed on the operation screen, allowing the operator to roughly check the observation points. This graphic display always appears after vacuum evacuation is completed, thus the operator can recognize the sample position at start of observation.

The motor drive stage is optional.



03 View at varying angles

OPTION

Tilting and Rotating Motor Drive Holder

Installation of this holder coupled with the motor drive stage allows for 4-axis motorized control.

The tilting and rotating motor drive holder is optional.

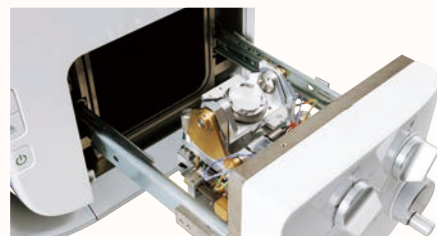

Tilt
0°

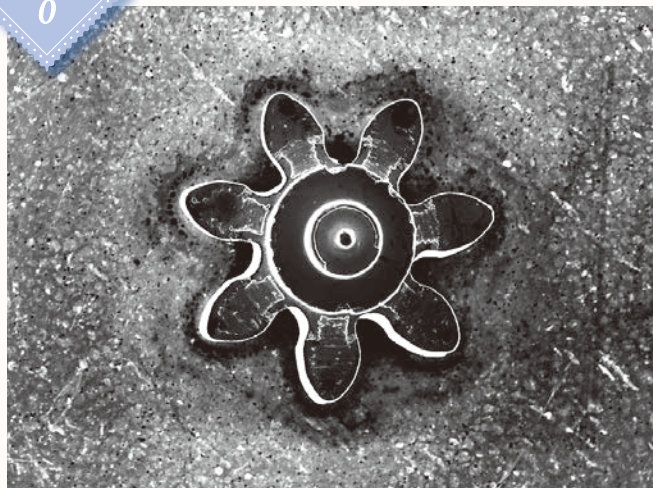

Sample: MEMS
Secondary electron image, Accelerating voltage 15 kV,
magnification $\times 90$
Tilt 0°

Tilt
30°



Sample: MEMS
Secondary electron image, Accelerating voltage 15 kV,
magnification $\times 90$
Tilt 30°

Quick response

Startup

Image observation (in LV mode) will start within 150 seconds after start of vacuum evacuation. The JCM-6000Plus will be ready for operation in 3 minutes after it is powered on.

Placing a sample and closing the chamber door will automatically initiate the evacuation sequence. An SEM image appears when the evacuation is completed.



Selecting High Vacuum or Low Vacuum mode

A single touch on the panel can switch between High-vacuum and Low-vacuum modes.

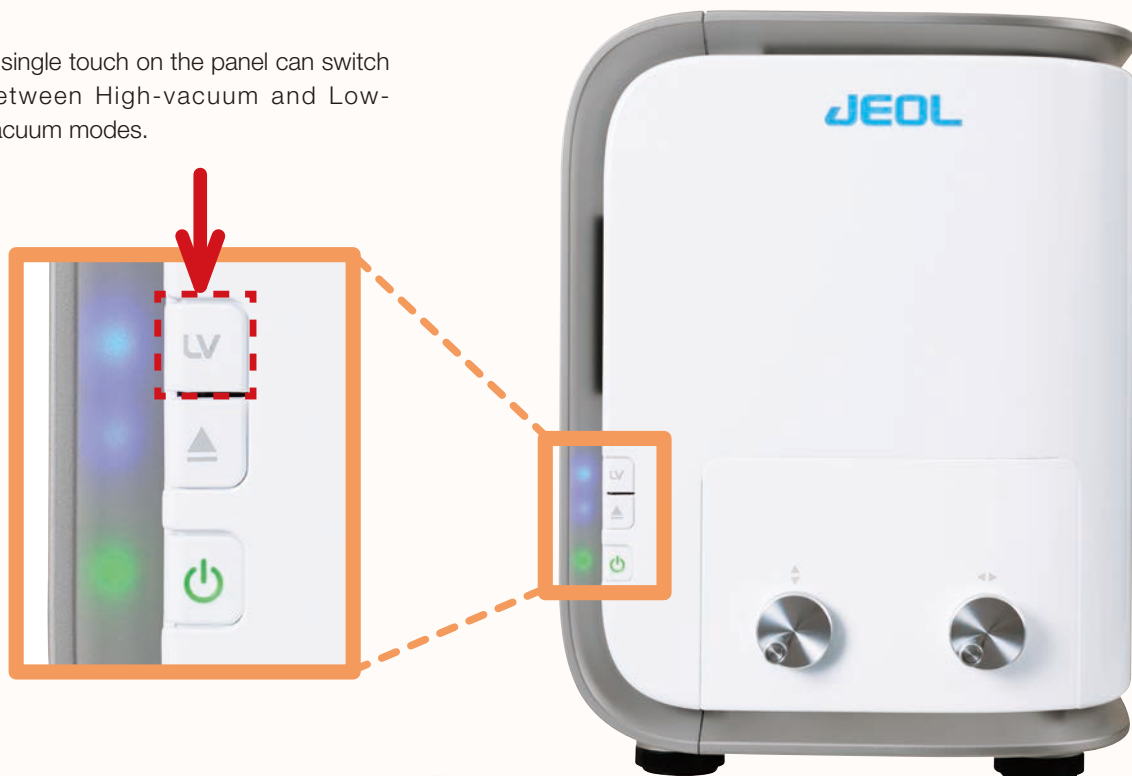

EDS analysis

NeoScope incorporates a JEOL proprietary dry SD detector. The detector is always ready for analysis during SEM imaging.

Easy maintenance

Filament

Changing filaments is easy.

Unlike a conventional filament assembly that requires cleaning of the Wehnelt, the electron gun in the NeoScope uses a pre-centered cartridge filament that is integrated with the Wehnelt. The cartridge is replaced as a unit making the exchange process quick while keeping correct positioning of the filament.

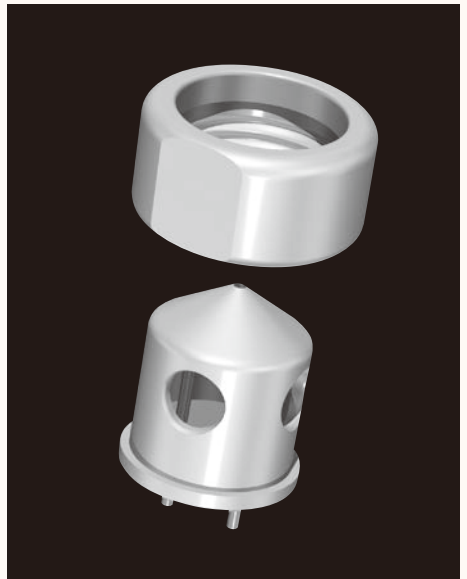

Integrated filament-Wehnelt grid

Auto gun alignment

Any new filament that is installed requires alignment to insure good image quality. This alignment process is fully automated in NeoScope.

No need for special facilities

JCM-6000Plus operates on a 100 V service outlet. Cooling water, compressed gas or liquid nitrogen are not required for SEM and EDS operation.

Peripherals

Coating device

Coating allows non conductive samples to be observed in the SEI mode under high vacuum. Comparing the SEI image with the low vacuum BEI image allows for closer examination of the fine surface structure.

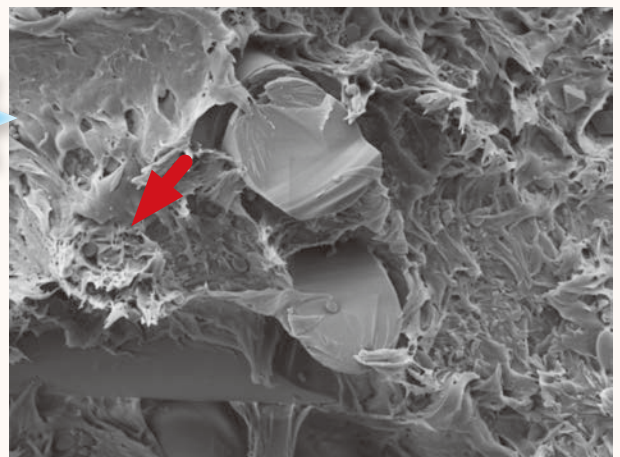
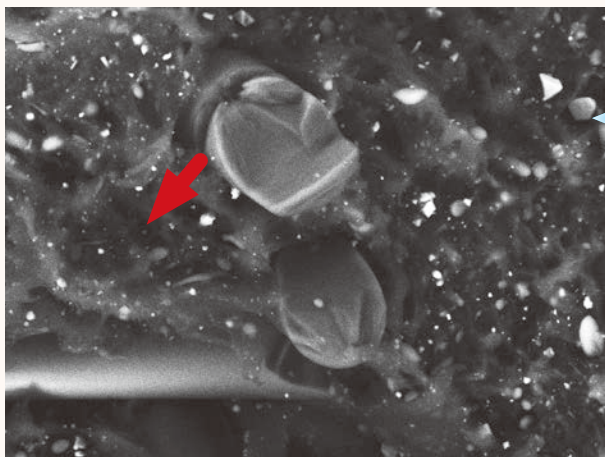

Sample: Resin fracture surface , Uncoated
Low Vacuum mode, backscattered electron image
Accelerating voltage: 15 kV; magnification: $\times 1,500$

Sample: Resin fracture surface, gold coated
High Vacuum mode, secondary electron image
Accelerating voltage: 15 kV; magnification: $\times 1,500$

Specifications

Direct magnification	Secondary electron image: ×10 to ×60,000 Backscattered electron image: ×10 to ×30,000 (Magnification is defined with a display size 120 mm × 90 mm)
Displayed magnification	Secondary electron image: ×23 to ×141,000 Backscattered electron image: ×23 to ×70,500 (Magnification is defined with a display size 282 mm × 211 mm)
Imaging mode	Secondary electron image, backscattered electron image
Accelerating voltage	Secondary electron image; 5 kV, 10 kV, 15 kV (3 stages) Backscattered electron image; 10 kV, 15 kV (2 stages)
Electron gun	Small gun with integrated filament-wehnelt cartridge
Bias current	Auto bias (linked to accelerating voltage and filament current)
Condenser lens	Two stage electromagnetic zoom condenser lens
Objective lens	Electromagnetic lens
Auto magnification correction	Magnification corrected with reference to sample height (7 mm, WD56 to 53 mm, WD10)
Preset magnification	6 levels, user programmable
Specimen stage	Manual control for X and Y: X: 35 mm, Y: 35 mm
Maximum sample size	70 mm diameter × 50 mm height
Specimen exchange	Draw-out mechanism
Image memory	One, 1,280 × 960 × 16 bits
Pixels	640 × 480, 1,280 × 960
Image processing	Pixel accumulation Image accumulation (recursible)
Automated functions	Filament, alignment, focus, stigmator, exposure
Metrology	Distance between 2 points, angles
File format	BMP, TIFF, JPEG
Computer	PC (desktop PC), OS Windows®7
Monitor	23 inch wide LCD monitor (touch panel)
Evacuation system	Fully automatic, TMP: 1, RP: 1

Optional accessories

- ◆ Tilt rotation motorized holder
Tilt: -15° to +45°; rotation: 360°
- ◆ EDS
- ◆ DII-29030SCTR Smart Coater
- ◆ Add the XY motor stage option

Installation requirements

Power supply	Voltage: Single phase AC 100 V (120 V, 220 V, 240 V) 50/60 Hz, 700 VA (AC 100 V), 840 VA (AC 120 V), 880 VA (AC 220 V), 960 VA (AC 240 V), Fluctuation ±10% or less, with grounding
Installation Room	Room temperature 15 to 30°C Humidity 60% or less Operation table Sturdy table with a loading capacity of 100 kg or more
Weight	Main console: approximately 50 kg RP: approximately 9 kg Power supply box: approximately 10 kg
Base unit dimensions	(Width) (Depth) (Height) 325 mm × 490 mm × 430 mm

- * Specifications subject to change without notice.
- * The official name of Windows7 is Microsoft(R), Windows(R), Operating System.
- * Windows is a registered trademark of Microsoft Corp. in the U.S.
- * Other trademarks referenced in this catalog and marked with* are the property of our allied companies.

System composition

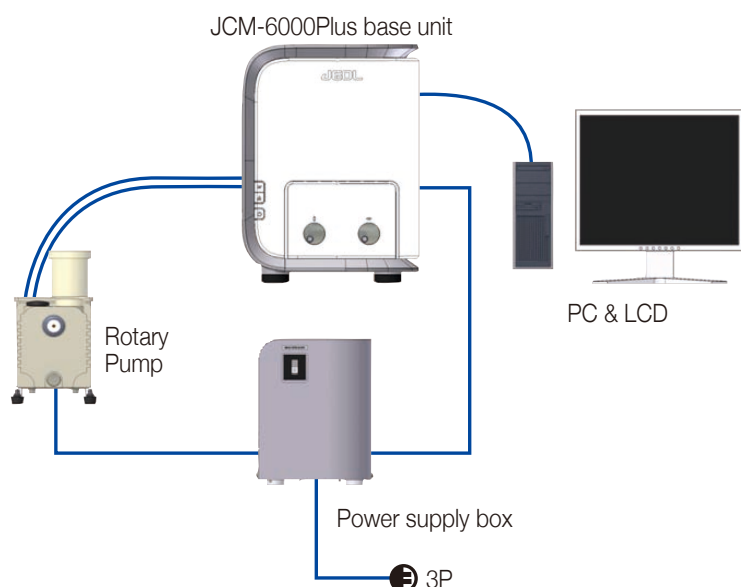

Index of samples	Page
Bug	3
Iron rust	4
Yogurt culture	6
Metal fracture surface	6
Patterns on Si	6
Coated paper	6
Mouse trachea	6
Sand eraser	7
Paper (LV)	7
Petal (Ageratamu) (LV)	7
Human hair	8
Star sand	9
Metal particles	9
Black ore (mineral)	10
MEMs	12
Resin fracture surface (LV, HV)	14